

GS2-6 SERIES:



6 Watts / Single Output

- 2.52 x 1.77 x 1.10" North American Wallmount Package
- 2.52 x 1.77 x 1.10" European Wallmount Package
- 2.71 x 1.65 x 1.06" Australian Wallmount Package
- 2.71 x 1.65 x 1.06" UK Wallmount Package

Features:

- Universal AC Input (90~264 VAC Input Range)
- Over Voltage / Current / Temperature Protection Circuits
- International Safety Approvals for Medical Applications
- Class B Emissions
- 2 Year Warranty

INPUT:

Input Voltage	90~264 VAC (Universal AC Input)
Input Frequency	47-63Hz
Inrush Current	30A @ 230 VAC (Max Cold Start)
Input Current	100mA maximum
Input Protection	Dual Fuse
Hold-Up Time	10ms Minimum
Leakage Current	100µA @ 240 VAC Maximum
Harmonics	EN61000-3-2 Class D Compliant

GENERAL:

Efficiency	60% minimum
Operating Temperature	0-40°C, derate linearly to 50% Load at 50°C
Storage Temperature	-100°C to +70°C
Cooling	Convection Cooled
Operating Humidity	5-95% RH, Non-Condensing
Vibration	5 ~ 50 Hz, acceleration 7.35 m/s*s on X,Y and Z Axis
MTBF	>100k Hrs at 25°C Full load

OUTPUT:

Minimum Load	n/a
Regulation	±3% max
Ripple & Noise	±1% typ. pk-pk @ 20MHz
Overload Protection	130~160% of I _{max} (auto-recovery)
Over Voltage	115~150% of nominal (latching)

APPROVALS:

Emissions	EN55011 Class B
Safety Approvals	UL/cUL 60601-1 TUV/GS EN60601-1 CE Mark (LVD)



GS2-6 SERIES:

Output Specifications:

Model:	Vout	Max Output Current
GS2x-006-050-A	5V	1200mA
GS2x-006-060-A	6V	1000mA
GS2x-006-070-A	7V	850mA
GS2x-006-080-A	8V	750mA
GS2x-006-090-A	9V	660mA
GS2x-006-100-A	10V	600mA
GS2x-006-120-A	12V	500mA
GS2x-006-130-A	13V	460mA
GS2x-006-140-A	14V	420mA
GS2x-006-150-A	15V	400mA
GS2x-006-240-A	24V	250mA

- Designate wallmount package by replacing "x" with:

U = North American Wallmount Package
T = European Wallmount Package

A = Australian Wallmount Package
B = UK Wallmount Package

- Additional suffix to designate output connector is required, see connector options at <http://advpower.com/dcconnector.pdf>

- Standard Output Cable Length is 6 feet.

U = North American Wallmount Package

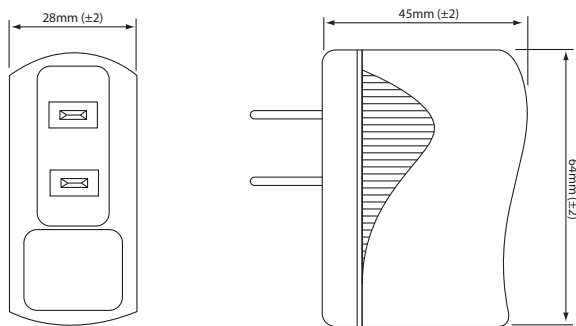

A = Australian Wallmount Package

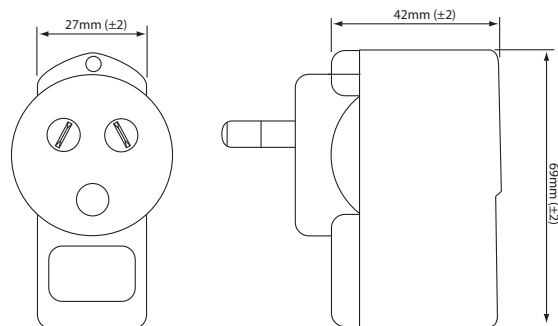

T = European Wallmount Package

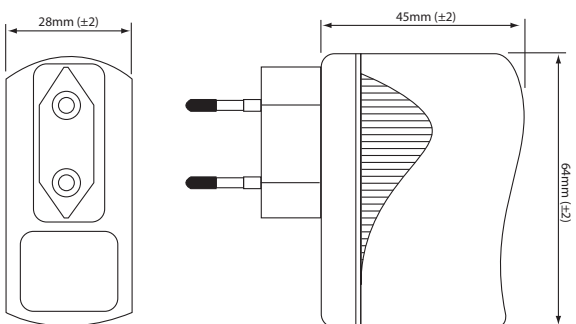

B = UK Wallmount Package

